



افراس للخدمات البيئية
AFRAS ENVIRONMENTAL SERVICES



Containers

Compactors

Waste
Bins

Customized
Solutions



Simple Solutions.
Reliable environmentally responsible

AFRAS Environmental Services

We've developed our Environmental Services over many years, and introduced techniques to make sure very high cleaning and hygienic standards are maintained in all kinds of situations, from clinics to universities and civic buildings.

What's more, our teams are managed by qualified administrative and supervision staff who are adept at organising service schedules, so you to get the very best from your outsourced Environmental Services.

When you choose Afras, you also benefit from the peace of mind of working with a company which listens, which delivers great service, and which works as a partner to ensure your Environmental Services needs are fully met.



Our mission is to achieve the Afras Vision, through:
focusing on the development of our staff; committing to quality and fair competition; meeting our clients' needs in the best way possible; expanding our customer base according to the needs of the market.



Customized Solutions



We offer our Solutions to :

Hospitals
Schools

Factories
Contracting

Shopping
Centres



Hotels
Resorts



Restaurants
Cafes



Waste types



Our Waste Management Sustainability Services, Public Sector Services and teams focus on how we can all better protect the environment

On-Services



AFRAS Management is committed to providing our commercial customers with the best service available. We offer a wide variety of commercial services to fit the needs of local businesses.

On-time



Collection Services by Professional Drivers
We know that timely, courteous and reliable collection is your number one priority. All our drivers receive comprehensive and ongoing training in safety and regulatory requirements. You can also depend on the responsiveness of our call dispatched services for emergency collection.

Loading Containers



Afras Environmental Services provides a variety of front-loading container sizes to fit your project needs.

Containers



Compactors Auto



Compactors Non Auto



Compactors leakproof no liquid

Containers



Waste Bins



Containers are empty by transport 10_{yds}



Containers are empty by transport 20_{yds}

Compactors Auto

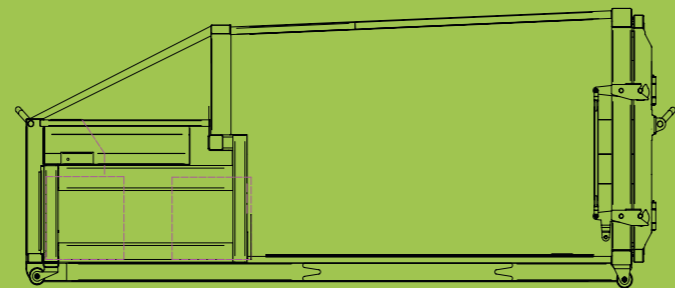

Different types of mobile compactors for Hook-Lift or Chain-Loader Trucks.

Fill safely – avoid accidents!



With each compaction cycle, the ram plate presses the goods in front of it into the body. During back stroke, the material in the filling device falls in front of the ram plate. Cover plates avoid throughout the “drag principle” that material falls behind the plunger. With this technology, the compactor can be filled without any interruption. Due to its conical shape, the compactor can be emptied very easily.

20 yds

Technical specifications

- Body capacity: 20 Cu. Yd.
- Electrically operated by 10 Hp Motor, 220 volt
- Compactor moves on special wheels that need no grease
- Loaded and dumped by hook system
- Suitable for market places, public squares, hospitals and school
- Tailgate provided with liquid leakage preventing seal
- Paint: sand plasting – 2 coats of antirust primer 2 coats of final finish paint according to required color
- Tailgate equipped with safety lock and open manually
- Length of loading opening 112 cm
- Width of loading opening 209 cm
- Height of loading opening 127 cm
- Total length 615 cm
- Total width 228 cm
- Automatic operation of the compactor
- A cap on the compactor does not work without closing
- Reserve the possibility of fluid inside

The use of these in:



Soft Waste



Organics



Cans, bottles and cartons

Compactors leakproof no liquid



- Suitable for wet waste
- Leakproof
- No cleaning of charge box required
- Top hinged door with ratchet closing mechanism
- Welded through
- Trouble-free discharge due to conical design
- Standard components
- Available with or without tipping device

Technical specifications

- Power: 5.5 kW
- Power supply: 400 V, 50 Hz
- Protection: 16 A träge
- Compaction force: 310 kN
- Volume per stroke: 0,72 cbm
- Volume per hour: theor. 92 cbm
- Time per working cycle: 29 s
- Filling height: 1.670 mm
- Filling opening: 1.000 x 1800 mm

The use of these in:



Soft Waste



Organics



Cans, bottles and cartons



Liquid

16 yds

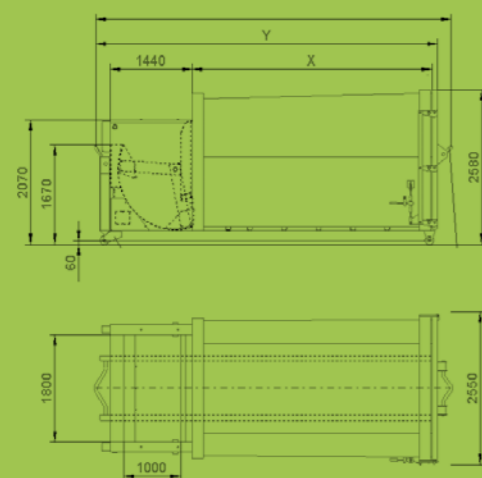

Due to the special ram, the enclosed hydraulic cylinders and its leakproof charge box, the compactor is well suited for the compaction of wet waste. Regular cleaning underneath and behind the ram of compactor is not required. As the machine is leakproof no liquid can escape, thus assisting in the clean and hygienic maintenance of the compactor area. The use of the compactor can be recommended for places where wet waste originates, i.e. hospitals, homes for the aged, hotels, large-scale catering establishments, markets, etc.

Compactors Non Auto



- Easy feeding and trouble-free discharge due to the smooth conical container construction (on 3 sides) without sections
- Galvanized ratchet closing mechanism
Robust safety bar in order to keep the door open while discharging
- Compactor floor made of high wear close-grained construction steel

Due to the innovative container construction without sections in connection with the well-considered and proven compactor technology a high compaction degree and consequently a higher filling density are ensured. The frequency of transport and, as a result, the costs for transport can be considerably reduced. The special form improves clearly the discharge.

Furthermore the smooth container walls can be used as a big advertising space.

20 yds

Technical specifications

- Power: 5.5 kW
- Compaction force: 340 kN
- Volume per stroke: 1.14 cbm
- Volume per hour: 95 cbm
- Time per working cycle: 43 s
- Ram penetration: 420 mm
- Filling opening bottom: 960 x 1.860 mm
- Filling opening top: 1.470 x 1.860 mm
- Filling height: 1.440 mm

The use of these in:



Soft Waste



Organics



Cans, bottles and cartons

Containers are empty **by transport**



We offer a great variety of skips for different intended use as well as options for all interest and purpose.

10 yds

- Welded inside and outside
- Bottom plate 4 mm
- Side wall plates 3 mm
- 2 fork-lift-pockets on each side
- Set of net hooks welded all around
- Primed and coated in RAL

The use of these in:



Solid Waste

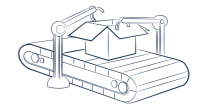

Factories



Construction & Demolition



Household Hazardous



Bulk



Landscape

Containers are empty by transport



Our "Standard Type" Heavy Duty Type , both available in different volumes and dimensions, give you the opportunity to select the perfect Ro-Ro-Container for your transport purpose.

20 yds

- Manufactured according to local standard
- Convex side panels
- Bottom (4 mm), sidewalls, front and doors (3mm) made of high grade steel S 460 MC
- Hook Ø 50 mm
- Subframe made of IPN 180
- Double twin door with middle lock
- Rollers with grease nipples Ø 160 mm
- Set of net hooks welded all around
- Ladder at front side (optional)
- Additional lock for safety door opening

The use of these in:



Solid Waste

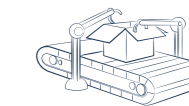

Factories



Construction & Demolition



Household Hazardous



Bulk

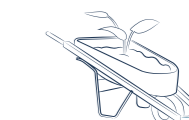

Landscape

Waste Bins



A complete program of individual galvanized bins for front and rear-loaders.
A lot of different supplements are available.

6 yds

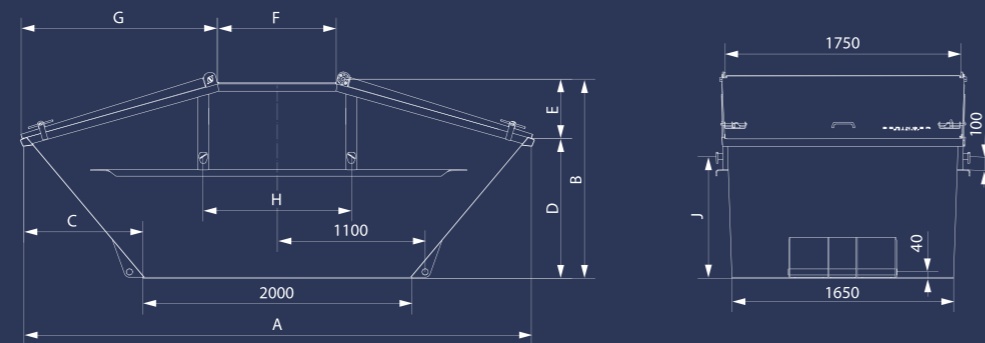

- Manufactured according to local standard
- Welded inside and outside
- Bottom plate 6 mm
- Side wall plates 4 mm
- Top frame beams cold rolled profile U-Channel
- Edges double welded
- Tripple-tipping device on both sides
- Set of net hooks welded all around

The use of these in:



Soft Waste



Organics



Landscape

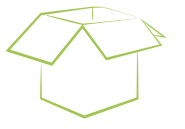

Cans, bottles and cartons

Why Afras services?

- We work in the service of the environment for more than 25 years
- We have the largest fleet of cars
- We have qualified human resources and an operating capacity
- The ability to devise appropriate environmental solutions to all sectors in the Kingdom
- We use the latest scientific techniques
- Apply the occupational health and safety standards
- Speed in performance and respond to the client's requirements